

# PRO MINI HOOP



designed by SKLZ»

## INSTRUCTION MANUAL

- INCLUDES:**
- » Pro Mini Hoop Classic
  - » Mini Ball

**IMPORTANT:**  
SAVE THIS INFORMATION IN THE EVENT THAT THE MANUFACTURER NEEDS TO BE CONTACTED FOR REPLACEMENT PARTS.

### ⚠ SAFETY INSTRUCTIONS:

FAILURE TO FOLLOW THESE SAFETY INSTRUCTIONS MAY RESULT IN SERIOUS INJURY OR PROPERTY DAMAGE AND WILL VOID YOUR WARRANTY.

Most injuries are caused by misuse and/or not following instructions. Use caution when using this product.

Thank you for choosing Pro Mini Hoop. If there is anything else we can do, don't hesitate to send us an email ([customerservice@sklz.com](mailto:customerservice@sklz.com)) or give us a call (1-877-225-7275).

### BEFORE YOU BEGIN:

- » Make sure you have all of the Pro Mini Hoop components.
- » Read all setup and usage instructions carefully.
- » Ensure your playing area is clear and remove any objects from the surrounding area to avoid damage or injury.
- » Always check for wear and tear before use. If any is found, do not use the product.

### ⚠ WARNING:

- » Do not hang on the rim in order to avoid damage to product or personal injury.

### ⚠ CAUTION:

- » Before use, make sure that the backboard is securely mounted.



[facebook.com/ProMiniHoop](https://facebook.com/ProMiniHoop)

## PRO MINI HOOP PARTS:

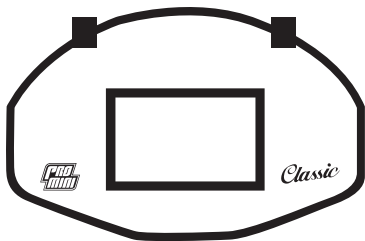

**A** BACKBOARD

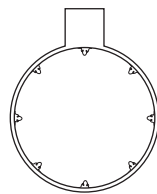

**B** RIM

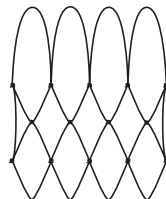

**C** NET

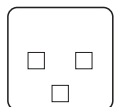

**D** RIM PLATE



**E** BOLTS (3)



**F** NUTS (3)



**G** WRENCH



**H** MINI BASKETBALL

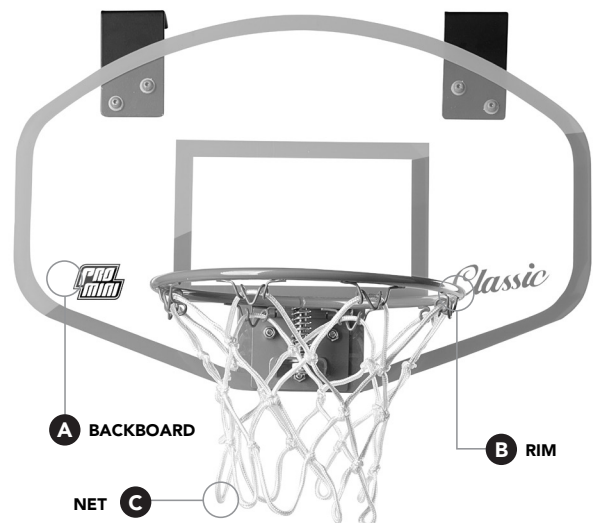

**A** BACKBOARD

**B** RIM

NET **C**

# PRO MINI HOOP ASSEMBLY

## STEP 1 RIM AND BACKBOARD ASSEMBLY

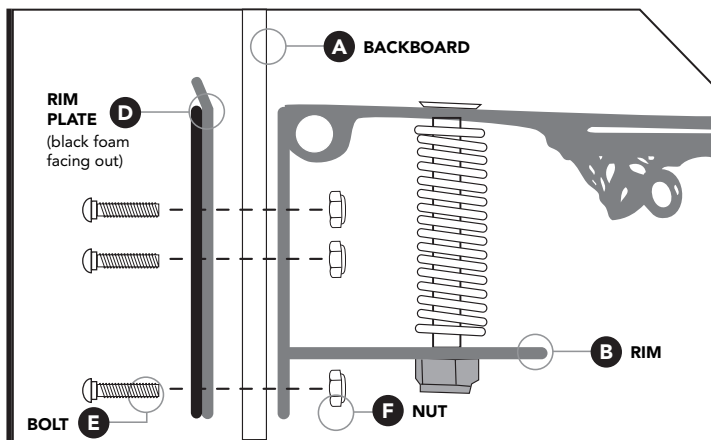

Align the holes on the Rim Plate (D) with the Backboard (A) fitting the Rim Plate against the back of the Backboard. Using the Bolts (E), attach the Rim Plate to the back of the Backboard making sure the square head of the screw fits securely to the square cut out on Rim Plate. Tighten each Nut (F) with a Wrench (G) to secure the Rim to the Backboard.

## STEP 2 ATTACHING THE NET

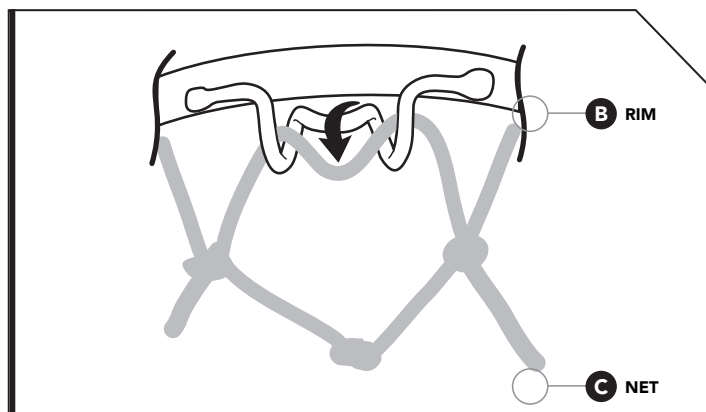

Attach the Net (C) to the Rim (B) by looping the long end of the Net over the metal loops.

SKLZ offers a limited 90-day warranty for this product, visit [SKLZ.com](https://www.sklz.com) for full warranty details and to register your product.